

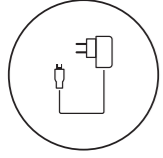

Smart Full HD Kablosuz Kamera  
Smart Hub destekli

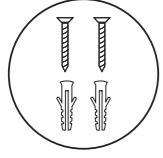

Güç Adaptörü



2 x Vida  
2 x Dübel

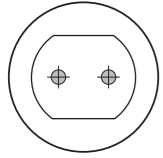

Hizalama Etiketi



Kolay Kurulum Klavuzu

## 1 Uygulamayı İndirin



**mydlink** olarak arayın ve uygulamayı indirin.

**Not:** Bu ürün, 'mydlink Home', 'mydlink Lite' vb. mydlink uygulamalarıyla uyumlu değildir.

## 2 Giriş Yapın



mydlink hesabınıza **giriş yapın** veya **kayıt olun**. mydlink Lite kullanıcıları aynı hesapla giriş yapabilirler.

## 3 Cihaz Ekleyin

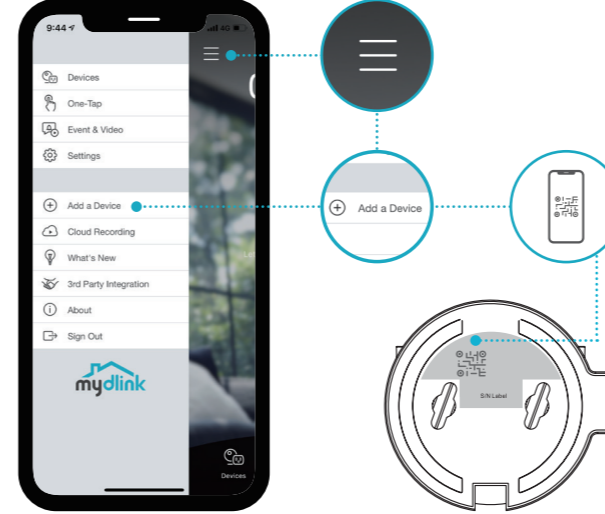

Menü düğmesine ☰ dokununuz, ardından **Cihaz Ekle**'ye dokununuz. Cihazdaki Kurulum Kodunu tarayın ve ardından uygulama yönergelerini takip edin.

## 4 Smart DIY Cihazlarınızın ayarlarını yapın

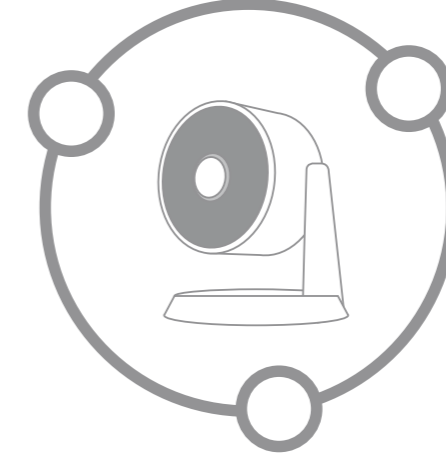

Smart DIY cihazlarınızın montajını yapmadan önce, yakındaki Smart Hub ile eşleştirin.

mydlink Smart DIY hakkında daha fazla bilgi için lütfen sitemizi ziyaret edin:

<https://dlink-me.com/supporttr/>

## i Cihaz Bilgileri

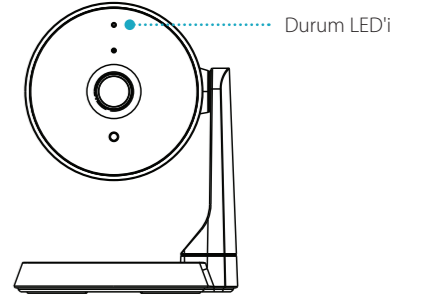

LED Davranışları

- Wi-Fi ve mydlink ağına bağlı.
- Açılıyor / Sıfırlanıyor
- **mydlink Smart DIY** cihazıyla eşleştiriliyor
- Kurulum hazır / Bağlantı kesildi
- Yazılım güncellemesi yapılıyor - cihazı kapatmayın.



## Placement

Place the camera at least 2 meters from the ground. The viewing distance for Person Detection is between 2 - 5 meters.

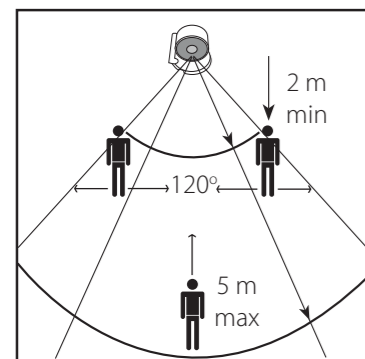
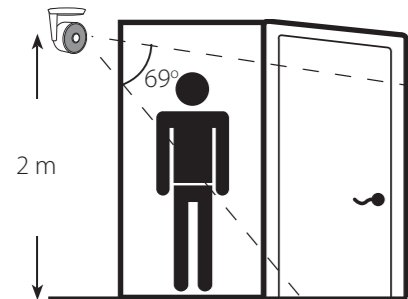

## Mounting

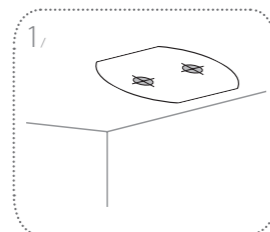

Stick the alignment sticker where you would like to place the camera.

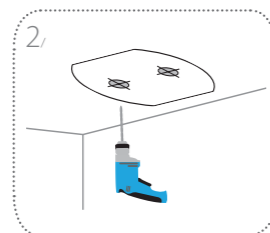

Use a 6 mm drill bit to drill two 3 mm deep holes as indicated on the alignment sticker.

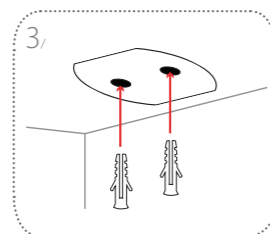

Hammer in the plastic wall anchors to support the screws.



## Mounting

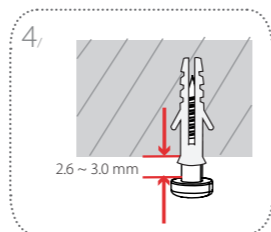

Twist the screws into the anchors, leaving the tops of the screws exposed from the surface. Do not over tighten the screws.

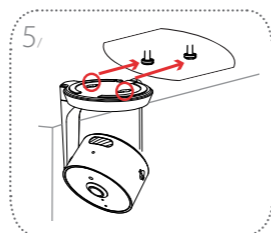

Align the mounting holes on the bottom of the camera with the screws. Slide the camera down to lock it into place.

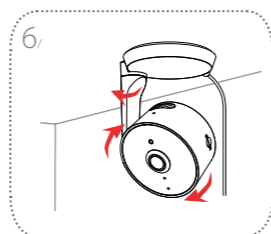

Twist the camera to your desired position. Go to the settings in the app and enable **Invert Image** if the image is up-side-down.



## FAQ

### What do I do if my device is not working properly?

Reset and reinstall your device. Use a paper clip to press the recessed **Reset** button and the LED will turn solid red.

During installation, ensure that:

- Your router is connected to the Internet and Wi-Fi is enabled
- Your mobile device is connected to your router's Wi-Fi and Bluetooth is enabled
- Your mydlink device is in range of your Wi-Fi network

### How can I use voice commands to control my device?

The device will work with both Amazon Alexa and the Google Assistant. For setup instructions on these services, visit the following websites:

**Amazon Alexa:**  
dlink.com/en/alexa

**The Google Assistant:**  
dlink.com/en/google-assistant

### Why is my microSD card not working/not supported?

The microSD card must be formatted into the correct file system (FAT32) before it can be used with this product. This can be done in the mydlink app by selecting the **Format** function in the storage menu under the device settings.

### What is my username and password for setting up my device with an ONVIF system?

To connect your device to an ONVIF system, key in **admin** as the username and use the PIN code of your mydlink device as the password. You can find the PIN code on your device's label.



## Support

Having trouble installing your new product? D-Link's website contains the latest user documentation and software updates for D-Link products. Australian and New Zealand customers can contact D-Link Technical Support through our website.

### Australia:

Tel: 1300-700-100

24/7 Technical Support

Web: <http://www.dlink.com.au>

E-mail: [support@dlink.com.au](mailto:support@dlink.com.au)

### New Zealand:

Tel: 0800-900-900

24/7 Technical Support

Web: <http://www.dlink.co.nz>

E-mail: [support@dlink.co.nz](mailto:support@dlink.co.nz)

Version 1.02 (AU)\_90x130  
2020/08/10  
6CS8330LHAU3G

Copyright ©2020 All rights reserved. D-Link and the D-Link logo are registered trademarks of D-Link Corporation or its subsidiaries. Product specifications, size and shape are subject to change without notice, and actual product appearance may differ from that depicted on the packaging. Visit [dlink.com](http://dlink.com) for more details.



DCS-8330LH  
Smart Full HD Wi-Fi Camera  
with built-in Smart Home Hub

## Quick Installation Guide

